

客戶 CUSTOMER: 華城電機股份有限公司 用途 USR: 高雄港第五櫃中心-79~81 號碼頭及櫃場改建工程	核准 APPROVED BY: 設計課 洪志勇	審核 CHECKED BY: 設計課 阮家豪	設計 DESIGNED BY: 設計課 謝啓彥	繪圖 DRAWER: 設計課 謝啓彥	<b>CH 建華電機股份有限公司</b> CHAN HUA MACHINERY & ELECTRIC CO. LTD. TEL:(04)23581130 FAX:(04)23581140 廠址:台中市南屯區工業 25 路 25 號 工號 WORKING NO.: 113010601 規劃日期: 113年04月12日 案號 DRAWING NO.: 比例 SCALE:	版次 REV:	修正摘要 SUMMARY:	日期 DATE:	圖名 TITLE: SS#2變電站單線圖(二)(79RMGC變電站)	
	<input type="checkbox"/> 保留圖		單位DM: 釐米 (mm)	圖號 DWG. NO.: BHA02 張數 SHEET NO.: / B02		版次 REV: 0				

3ø3W 11.4kV 60HZ

- CB21A31 PANEL 於線號前"\*"填入1
- CB21A32 PANEL 於線號前"\*"填入2
- CB21A33 PANEL 於線號前"\*"填入3
- CB21A34 PANEL 於線號前"\*"填入4
- CB21A35 PANEL 於線號前"\*"填入5

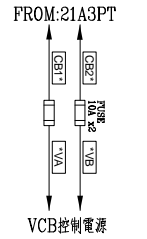
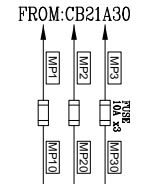
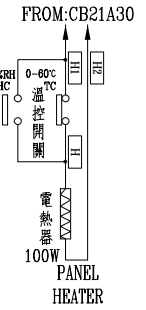
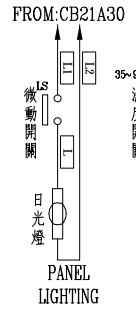

VCB  
24kV 16kA 630A  
20-VPR-16D

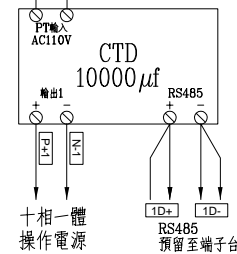
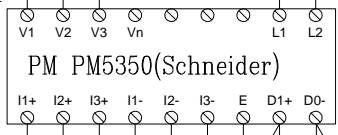
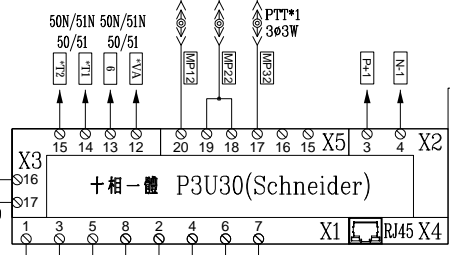
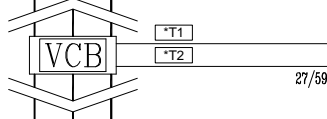

CT-3 24kV  
60-30/5A  
5P20 15VA  
(FOR RELAY)

60-30/5A  
1.0class 30VA  
(FOR METER)

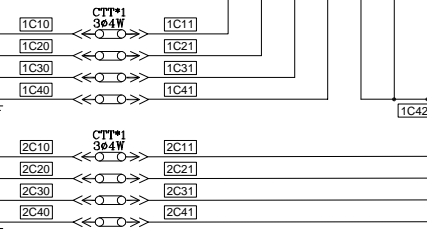

3ø3W 11.4kV 60HZ

客戶 CUSTOMER: 華城電機股份有限公司  用途 USR: 高雄港第五櫃中心-79~81 號碼頭及櫃場改建工程	核准 APPROVED BY: 設計課 洪志勇	審核 CHECKED BY: 設計課 阮家豪	設計 DESIGNED BY: 設計課 謝啓彥	繪圖 DRAWER: 設計課 謝啓彥	版次 REV  修正摘要 SUMMARY  日期 DATE	圖名 TITLE: SS#2變電站複線圖(79RMGC變電站) CB21A31、CB21A32、CB21A33 、CB21A34、CB21A35 PANEL  圖號 DWG. NO.: BHB06 張數 SHEET NO.: / B08
	案號 DRAWING NO.: 113010601 工號 WORKING NO.: 113010601 廠址: 台中市南屯區工業 25 路 25 號					

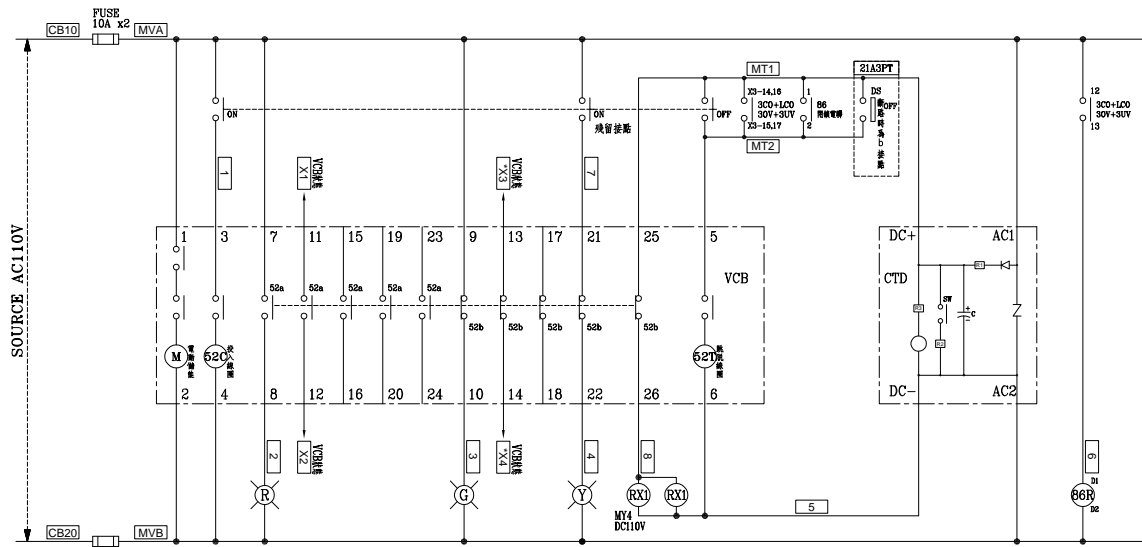

CB21A30 PANEL MITSUBISHI "VCB" 控制圖

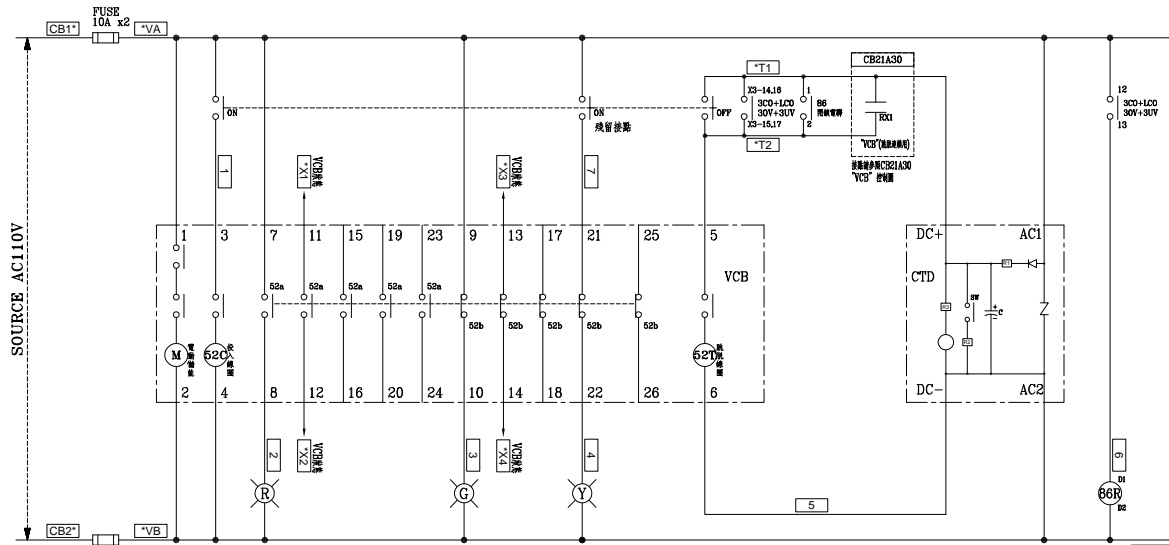
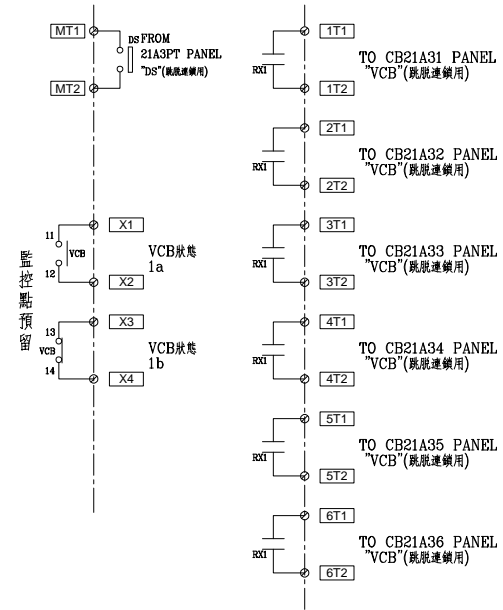

MITSUBISHI "VCB" 控制圖

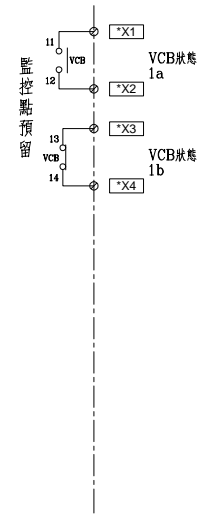

CB21A31 PANEL 於線號前"*"填入1	CB21A33 PANEL 於線號前"*"填入3	CB21A35 PANEL 於線號前"*"填入5
CB21A32 PANEL 於線號前"*"填入2	CB21A34 PANEL 於線號前"*"填入4	CB21A36 PANEL 於線號前"*"填入6

客戶 CUSTOMER: 華城電機股份有限公司  用途 USR: 高雄港第五櫃中心-79~81 號碼頭及櫃場改建工程	核准 APPROVED BY: 設計課 洪志勇	審核 CHECKED BY: 設計課 阮家豪	設計 DESIGNED BY: 設計課 謝啓彥	繪圖 DRAWER: 設計課 謝啓彥	版次 REV  修正摘要 SUMMARY  日期 DATE  圖名 TITLE: SS#2變電站複線圖(79RMGC變電站) CB21A30、CB21A31、CB21A32、CB21A33 、CB21A34、CB21A35、CB21A36 PANEL  圖號 DWG. NO.: BHC02 張數 SHEET NO.: / B12	圖名 TITLE: SS#2變電站複線圖(79RMGC變電站) CB21A30、CB21A31、CB21A32、CB21A33 、CB21A34、CB21A35、CB21A36 PANEL  圖號 DWG. NO.: BHC02 張數 SHEET NO.: / B12
	建華機電股份有限公司 CHAN HUA MACHINERY & ELECTRIC CO., LTD. TEL: (04)23581130 FAX: (04)23581140 廠址: 台中市南屯區工業 25 路 25 號  工號 WORKING NO.: 113010601 案號 DRAWING NO.:  規畫日期 DATE: 113年04月12日 比例 SCALE:					